





GENUINE COVER ASSY-TONNEAU

INSTALLATION AND USER'S INSTRUCTIONS

Thank you for purchasing a genuine Mazda accessory.
Before removal and installation, be sure to thoroughly read these instructions.
Please read the contents of this booklet in order to properly install and use the cover assy-tonneau. Your safety depends on it.
Keep these instructions with your vehicle records for future reference.

WARNING

- There are several  **WARNING** and  **CAUTION** sections in this booklet concerning safety when installing or removing the cover assy-tonneau. Always read and follow them in order to prevent injuries, accidents, and possible damage to the vehicle.
 -  **WARNING:** Indicates a situation in which serious injury or death could result if the warning is ignored.
 -  **CAUTION:** Indicates a situation in which bodily injury or damage to the vehicle could result if the caution is ignored.
- For areas indicating the tightening torque in this instruction manual, tighten to the specified torque using a torque wrench. For areas in which the tightening torque is indicated inside parentheses (), the tightening torque is indicated as a reference value, however tightening using a torque wrench is not necessary.
- Do not modify the cover assy-tonneau.
- Do not install the cover assy-tonneau in any way other than described in the following instructions.
- If in any doubt, please ask your Mazda dealer to install the accessory in order to prevent errors in installation.
- If you have any questions about the use of the accessory, ask your Mazda dealer for proper advice before using it.
- Mazda and its suppliers are not responsible for injuries, accidents, and damage to persons and property that arise from the failure of the dealer or installer to follow these instructions.
- To ensure safety and reliability of the work, installation, removal and disposal work must be carried out by an Authorized Mazda Dealership.
- Be careful not to lose removed parts, and be sure that they are kept free from scratches, grease or other dirt.

PART NAME: COVER ASSY-TONNEAU
PART NUMBER: KB7W V1 350
VEHICLE: CX-5

NOTE

To the dealer

- Please turn over these instructions to the customer after installation.

To the customer

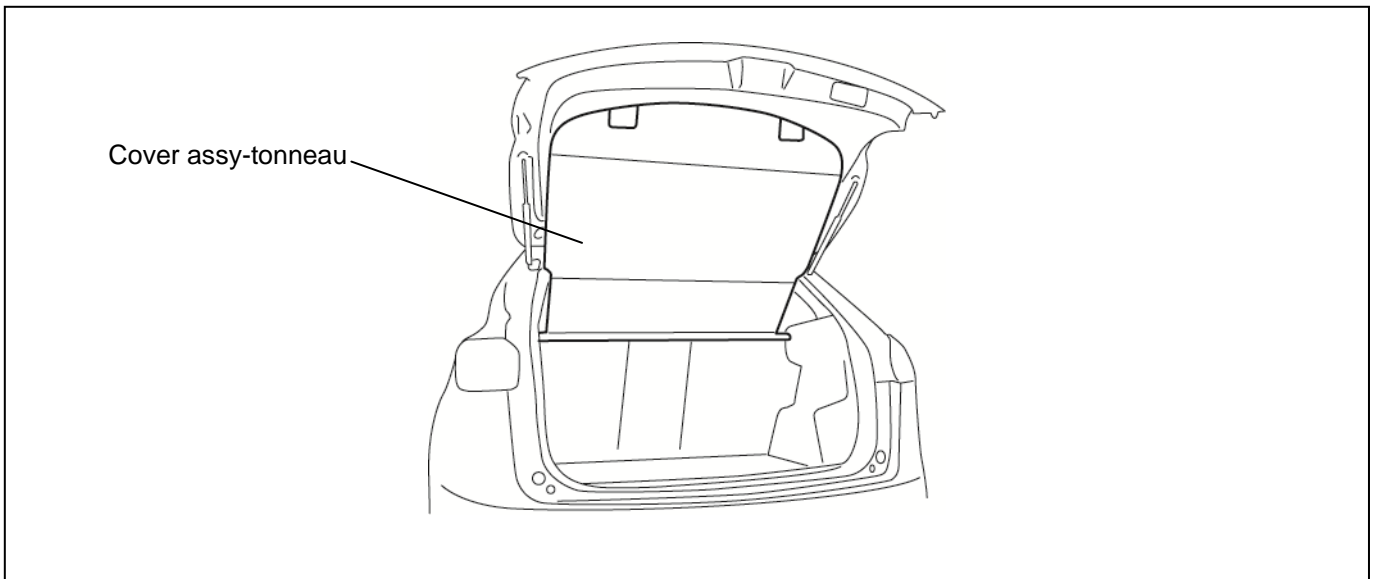

- Keep these instructions after installation. The instructions may be necessary for installing other optional parts or removal of this accessory.
- Should the vehicle or this accessory be resold, always leave these instructions with it for the next owner.

1. INSTALLATION VIEW

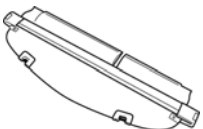

2. PARTS

- Before installation, verify that the kit includes all the following parts and that they are free of dirt, scratches, or damage.

Part	Part name	Qty	Part	Part name	Qty
	COVER ASSY-TONNEAU	1		Installation and user's instructions	1

3. BEFORE INSTALLATION

⚠ CAUTION

Place the removed parts and kit accessories on a protective sheet to prevent scratches.

Do not hold by the flap when lifting, otherwise damage may occur.

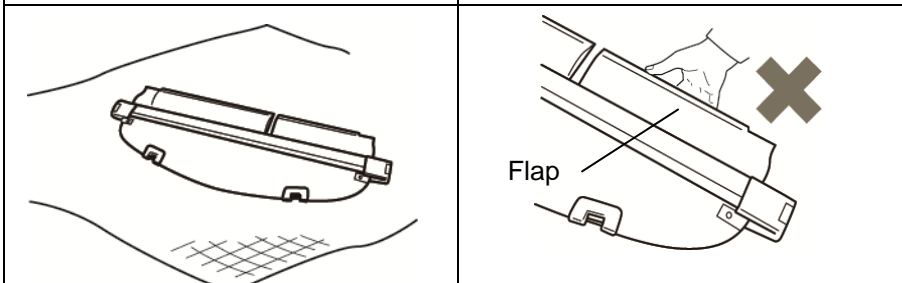

⚠ WARNING

- Park the vehicle on a flat, level surface, set the selector lever to P (AT vehicles) or the shift lever to 1st or R (MT vehicles), apply the parking brake and block the wheels so that the vehicle does not move during installation.

4. INSTALLATION OF COVER ASSY - TONNEAU

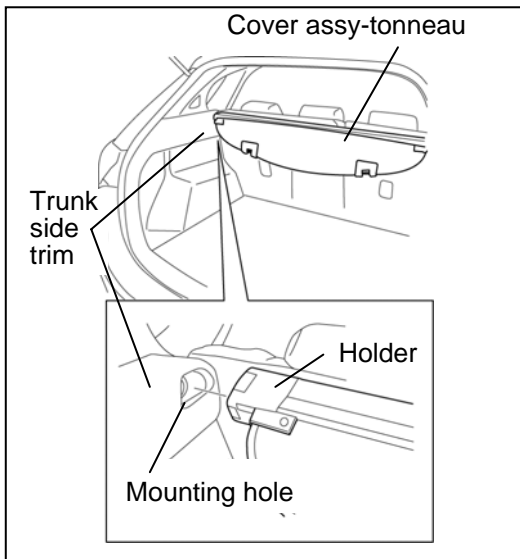

1. Insert the holder on the left end of the cover assy-tonneau into the mounting hole of the trunk side trim.

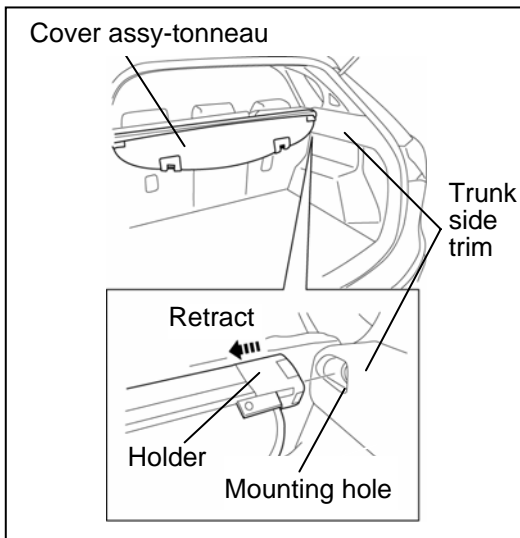

2. Retract the holder on the right end of the cover assy-tonneau and insert it into the mounting hole.

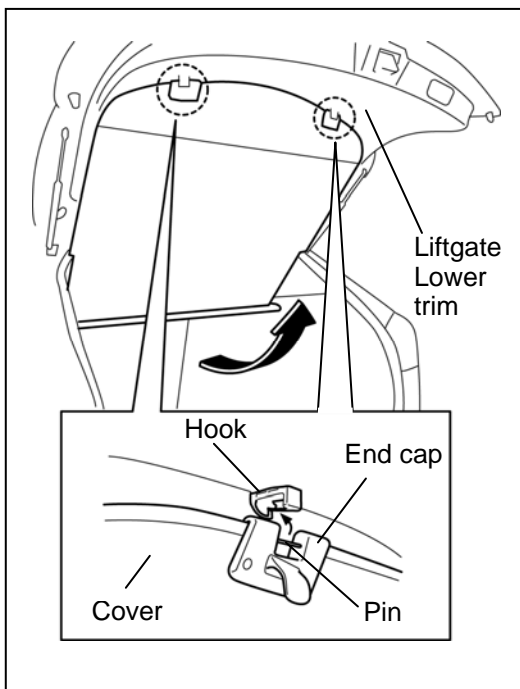

3. Slowly pull out the cover and secure the cover ends (end cap pins) into the liftgate lower trim retainers (2 locations).

⚠ CAUTION

- Verify that the cover assy-tonneau is securely mounted. If it is left unsecured while driving, it could unexpectedly fly off the retainers and cause injury.

-TO THE CUSTOMER-

- Do not hold by the flap when lifting. Damage may occur.
- Use a mild detergent to clean the cover assy-tonneau. Do not use any organic solvent such as thinner or benzene. Otherwise the cover assy-tonneau could be damaged.
- If liquids containing alcohol (such as thinner, wax, pesticide), or juice is splashed on the cover assy-tonneau, gently pat it with a soft cloth immediately and wipe it off. Otherwise, the cover could deform or change color.
- When installing/removing the cover assy-tonneau, always do so with the cover completely rolled up inside the case.

⚠ WARNING

- Do not place objects on the cover assy-tonneau. Such objects could move suddenly while driving and cause a serious accident.

Consult your Mazda dealer if you have any questions regarding this accessory.

COVER ASSY-TONNEAU REMOVAL/STORAGE

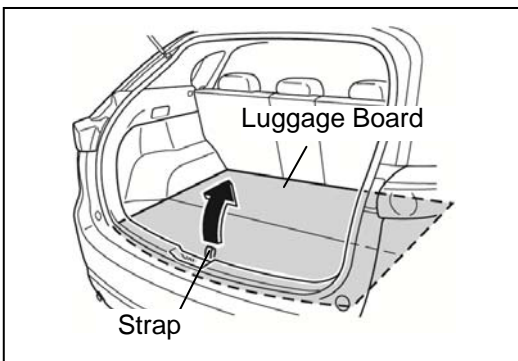

1. Remove the cover assy-tonneau in the reverse order of installation.
2. Pull the strap to open the luggage board.

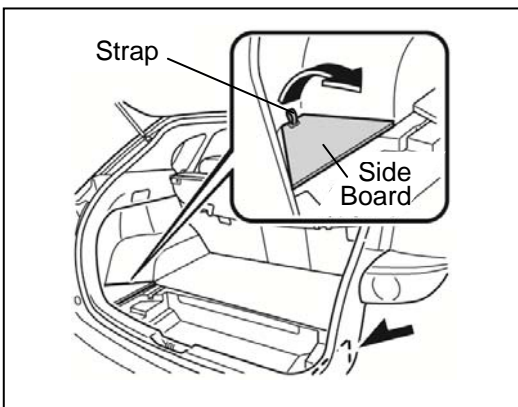

3. Pull the straps of the side boards on each side of the luggage compartment to remove them.

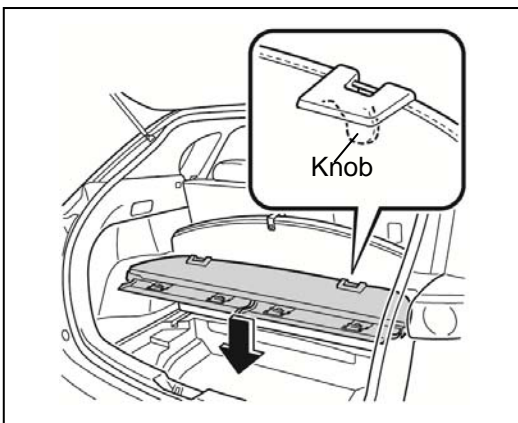

4. Store the cover assy-tonneau with the knob facing downward.
5. Return the side boards to their original positions and close the luggage board.